

A Real Time GPS Reference Network for Recife, Brazil, Enabling Precise and Reliable Cadastral Surveys

**Stefan WILLGALIS and Prof. Günter SEEBER, Germany and Prof. Cláudia Pereira
KRUEGER and Prof. Verônica M.C. ROMÃO, Brazil**

Key words: Precise Real Time GPS Positioning, RTK Networks, Active Reference Frames.

ABSTRACT

The establishment and maintenance of geodetic reference frames which are an essential foundation for all surveys related to land management, GIS and large scale mapping are very expensive. Large countries like Brazil cannot afford a dense, nation-wide control network. Active GPS reference stations provide an alternative concept for reference frames. Because of the high potential of relative, carrier phase based GPS measurements it is sufficient, to tie GPS surveys to the next reference station with precisely known coordinates. The connection to adjacent control monuments is not required as long as network distortions can be either neglected or modelled. Therefore the effort for a classical monumented networks can be reduced drastically.

For those applications requiring sub decimetre or even centimetre-level accuracy in real time, the working radius of a field station is limited to less than 10 km from the next reference station, especially in the equatorial region. To overcome this unsatisfactory situation, the spatial and temporal correlations of GPS measurement errors introduced by ionosphere, troposphere, and satellite orbit need to be modelled in a real time multi station solution. A concept for such a local GPS reference network covering only densely populated areas or an important economic region has been developed in a collaborative Brazilian-German research project.

In the paper, we discuss the set up of a local GPS reference network that was operated in the urban area of Recife during November 2000, and positioning results for control and cadastral surveys are given. The real time multi station solutions yield more precise, more reliable, and much faster results, but are still limited by strong ionospheric anomalies.

RESUMO

A implantação e manutenção de redes de referência geodésicas, essenciais para todos os levantamentos relacionados ao gerenciamento territorial, GIS e mapeamento em escalas grandes, são muito dispendiosas. Países com grandes extensões territoriais, como o Brasil, não tem condições de desenvolver uma rede de controle ampla e densa em todo seu território. Estações GPS ativas fornecem um conceito alternativo para redes de referência. Devido ao alto potencial das medições GPS de fase das portadoras, é suficiente amarrar os levantamentos GPS a uma estação de referência próxima com coordenadas precisamente conhecidas. A conexão a um marco de controle adjacente não é requerida quando as

distorções na rede podem ser negligenciadas ou modeladas. Desta forma, os esforços para uma monumentação clássica de redes podem ser drasticamente reduzidos.

Para aplicações que requerem precisão em tempo real em nível sub decimétrico ou mesmo centimétrico, o raio de aplicação é limitado a menos de 10 km da estação de referência, especialmente em regiões equatoriais. Para contornar essa situação, as correlações temporais e espaciais dos erros de medição GPS, introduzidos pela ionosfera, troposfera e órbita dos satélites, precisam ser modelados através de uma solução de múltiplas estações em tempo real. Um conceito para um tipo de rede de referência GPS, cobrindo áreas populosas ou regiões economicamente importantes, foi desenvolvido dentro de um projeto de pesquisa bilateral Brasil-Alemanha.

Neste trabalho é discutida a instalação de uma rede de referência que foi operada durante o mês de Novembro de 2000 na área urbana de Recife, e os resultados dos levantamentos cadastrais e de pontos de controle são apresentados. As soluções de múltiplas estações em tempo real produzem maior precisão, maior confiabilidade e soluções mais rápidas, mas ainda são limitadas pelas fortes anomalias ionosféricas.

CONTACT

Dipl.-Ing. Stefan Willgalis and Prof. Dr.-Ing. Günter Seeber
Institut für Erdmessung
Universität Hannover
Schneiderberg 50
30167 Hannover
GERMANY
Tel. + 49 511 762 5149
Fax + 49 511 762 4006
E-mail: willgalis@ife.uni-hannover.de and seeber@ife.uni-hannover.de

Prof^a. Dr. Cláudia Pereira Krueger
Departamento de Geomática, Universidade Federal do Paraná (UFPR)
Centro Politécnico, Jardim das Américas, Curitiba
CEP 81531-990, Paraná
BRAZIL
Tel. + 55 41 361 3064
Fax + 55 41 266 2393
E-mail: ckruieger@cce.ufpr.br

Prof^a. Dr. Verônica M.C. Romão
Departamento de Engenharia Cartográfica, Universidade Federal de Pernambuco (UFPE)
Av. Acadêmico Hélio Ramos, Recife
CEP 50740-530, Pernambuco
BRAZIL
Tel. /Fax + 55 81 271 8235
E-mail: vcosta@npd.ufpe.br

A Real Time GPS Reference Network for Recife, Brazil, Enabling Precise and Reliable Cadastral Surveys

Stefan WILLGALIS and Prof. Günter SEEBER, Germany and Prof. Cláudia Pereira
KRUEGER and Prof. Verônica M.C. ROMÃO, Brazil

1. INTRODUCTION

GPS is a precise and reliable tool in a wide range of surveying applications. For the establishment and densification of geodetic networks it is the most economical surveying tool. As long as only few stations with longer interstation distances are involved, static observations of more than a quarter of an hour and extensive post processing in the office is tolerable.

Cadastral surveys, on the contrary, require observation methods that provide position information within a short time span in the field. Only if mass production is feasible, GPS can compete with traditional surveying methods like e.g. tacheometry. The introduction of RTK systems enabled users for the first time to perform detailed surveys economically. Although a reasonable method, its limitations are evident. The requirement to operate a base station is awkward and quite often it is impractical. The limited baseline length of just a few km impedes effective survey work.

RTK networks enable precise real time positioning capability for a much larger area. Operated by State Survey Authorities or private companies as a permanent precise (P)DGPS service, such networks simultaneously provide an active reference frame to which all GPS users can easily connect to.

2. FROM RAPID TO PRECISE REAL TIME POSITIONING

Rapid GPS methods have been developed to reduce the long observation times of one hour and more for static GPS surveys (Fig. 1). These methods can be divided into rapid static, semi kinematic (stop&go) and pure kinematic methods (*Seeber 1993*). In the static mode, only the coordinates of a stationary antenna are recorded, in the kinematic mode the entire trajectory is determined. For all three methods, the solutions are usually derived in post processing. The stop&go technique is close to the requirements for real time positioning. If ambiguities are resolved, the GPS signals must be locked continuously while the rovers move from one point to the next. As long as the ambiguities are kept fixed, a single measurement (epoch) is in principle sufficient for a precise determination of coordinate differences between two GPS receivers

$$X_{rov} = X_{RS} + \Delta X_{RS-rov} \quad \text{with} \quad \Delta X_{RS-rov} = [\Delta X, \Delta Y, \Delta Z]^T. \quad (1)$$

RTK systems consisting of two GPS receivers, an UHF data link for real time corrections, and a processing software with OTW (on the way) ambiguity resolution algorithm overcomes the drawbacks of the stop&go method. Cycle slips due to signal obstructions are detected immediately and ambiguities are quickly resolved again. But RTK systems also have a major disadvantage, the baseline length is limited to between 5 and 10 km (Fig. 2). At first, this is due to the limited range of the UHF radio link and secondly, RTK systems estimate the posi-

tion using L1 solutions only, even if a dual-frequency receiver is employed for faster ambiguity resolution. The distance between base and rover is for real time methods as important as for rapid methods. GPS satellite orbit errors and GPS signal delays caused by the ionosphere and the troposphere are spatially correlated. These errors decorrelate with increasing interstation distance, and the errors will not cancel out by differencing the observations of the two stations. In order to extend the working range, multi station or network RTK is crucial.

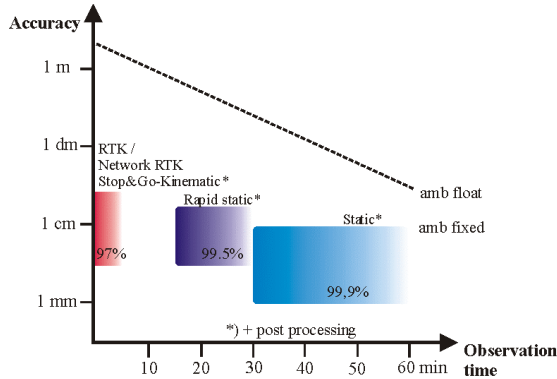

Figure 1: Obtainable accuracy and reliability depending on observation time and positioning method

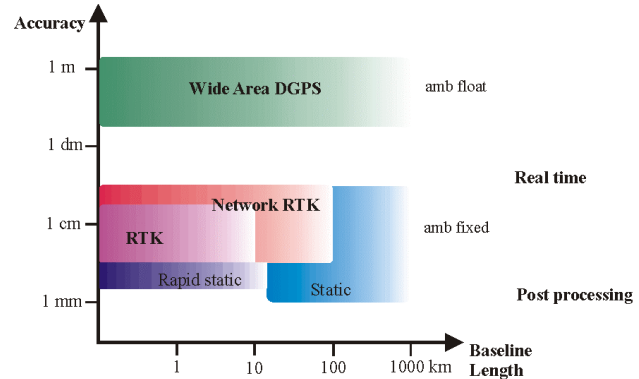

Figure 2: Range dependent accuracy of different GPS positioning methods

For RTK networks in Germany, a reference station spacing of 50-70 km was chosen following investigations by *Fröhlich (1994)*. This distances correspond to the range of the commonly used VHF radio link. With about 30 km distance to the next reference station, a rover is able to initialize the ambiguities within a few minutes. A larger station spacing is desirable for economical reasons, but beyond 100 km the time for ambiguity fixing increases drastically and post processing solutions become competitive again. If sub-meter accuracy is sufficient, wide area networks of national or continental extension are an alternative for real time positioning (Fig. 2). Since they rely on float solutions, i.e. do not fix ambiguities, cm accuracy can never be obtained. Even a global DGPS (GDGPS) is under investigation (*Muellerschoen et al. 2001*).

3. RTK NETWORK APPROACHES

The range of standard RTK systems is limited since the spatial correlation of atmospheric and satellite orbit errors decreases with the separation between reference station and rover. Thus, the distance dependent errors in the undifferenced GPS observation equation (2) cannot be completely eliminated by the most commonly used double differencing approach. This slows down the carrier phase ambiguity resolution process and eventually the process will fail. Without fixed ambiguities, however, precise positioning with cm accuracy is impossible.

$$PR_j^i = |\vec{R}_j^i| + \delta t^i - \delta t_j \pm \delta I_j^i + \delta T_j^i + \delta O^i + \delta A_j^i + \delta M_j^i + \lambda N_j^i + \varepsilon_j^i \quad (2)$$

with

$$\vec{R}_j^i = \vec{X}^i - \vec{X}_j \quad \text{geometric range between satellite (i) and receiver (j) antenna phase centres}$$

$$\delta t^i, \delta t_j \quad \text{satellite and receiver clock (t) error, including signal specific delays}$$

$\delta I_j^i, \delta T_j^i, \delta O^i$	distance dependent biases: ionospheric (I) and tropospheric (T) delay, orbit error (O)
$\delta A_j^i, \delta M_j^i$	station dependent biases: antenna phase centre variations (A), multipath (M)
λN_j^i	carrier phase ambiguity
ε_j^i	random measurement error

In RTK networks the spatial and temporal correlation of distance dependent errors is determined using observations from several GPS reference stations with precisely known coordinates. The residuals at these stations are used to derive an interpolation model that is used in turn to derive corrections for the location of any rover within the network. This enables the fast and correct ambiguity resolution, so that the coordinates of the rover can be precisely determined almost independent of the distance to the next reference station.

Several approaches for precise DGPS (PDGPS) networks, as they are also called, have been proposed. Most of the investigations concentrate on suitable interpolation models as e.g. compared by *Dai et al. 2001* or by *Fotopoulos 2000*. Another focus is on concepts, how the corrections can be disseminated and utilized by a rover. Different ways of data communication, mainly classified into one-way communication links (broadcast per radio link, FM sub-carrier, TV audio RF sub-carrier) and two-way-communication links (e.g. cellular phones) including their respective bandwidth, have to be considered. Often the use of existing RTK hardware and software is an important requirement. Hence, different solutions based on Virtual Reference Stations (VRS) (*Wanninger 2000, Vollath et al. 2000*), on a network grid (*Townsend et al. 1999*) or on functional corrections (e.g. FKP) (*Wübbena et al. 1996*) have been developed.

The most important and fundamental difference between those solutions exists in the parameter treatment of the observation equation. Following the principle of parameter elimination, most software packages rely on double differencing where the correlated errors will vanish. Thus, all information on the error characteristic is lost. The individual error components are lumped together for the correction.

An alternative approach is the parameter estimation model. Each error component is individually modelled on a per satellite and per epoch basis. The orbit error components, SV clock errors as well as estimates of the ionospheric and tropospheric delay are described in an error vector (3) that can also be regarded as a state vector. Therefore, this model is also denoted as state space approach (*Wübbena, Willgalis 2001*).

$$x = [X_j, N_j^i, \delta t_j, \delta t^i, \delta O^i, \delta T_j^i, \delta I_j^i, \delta M_j^i]^T \quad (3)$$

Due to practical considerations a combination of state estimation for the determination of parameters and of a low-order surface model for the dissemination of corrections was employed for the reference network in Recife. The state parameter were derived from the four reference stations of the network. The network corrections, denoted as area correction parameters (FKP), for the location of a rover were derived from a correction function in form of an inclined plane.

The state parameters can be divided into global, regional, and local parameters. The global parameters orbit, SV clock, and global ionosphere are spatially strongly correlated. They can

be determined at best in a larger network of national or continental extension. Small and medium scale variations of the ionosphere and troposphere make up the regional parameters. They show only little spatial correlation and need therefore a dense network of reference stations for their estimation. Local parameters like multipath are solely station dependent and spatially uncorrelated with multipath at other sites. Attempts are made to average out multipath by filtering in the state space model. Another promising approach is the multipath calibration of each reference station site (Böder *et al.* 2001), taking advantage of the fixed antenna-reflector geometry at each site and the repetitive satellite constellation. The use of absolute calibrated antennas (Menge 1998) is definitely required if different antenna types are employed at reference and rover stations.

Global and regional state parameters need not necessarily to be estimated in the same network. Precise ephemeris for instance are determined in the global IGS network but can be introduced in any other GPS survey. This idea, pursued consequently, leads to an adapted PDGPS network concept for large countries like Brazil. Similar to the classical hierarchical concept of geodetic control networks, one first order nation wide GPS network and several local networks of second order are set up (Fig. 3). The reference station spacing of the first order network is chosen such that ambiguity resolution is safely possible in acceptable short time. It could be based on the existing Continuous Brazilian Monitoring Network (RBMC) maintained by the Instituto Brasileiro de Geografia e Estatística (IBGE). The global state parameters estimated in this network are then forwarded to the second order networks that are set up to cover only densely populated areas and important economic regions. From the combined global and regional state parameters network corrections can be derived. The different regional networks do not need to be connected. Reference stations of the global network can simultaneously serve as a regional reference station. That this idea is in principle feasible has been demonstrated for a sub-net within the satellite positioning service of the German state survey authorities (SAPOS) by investigations of Wübbena, Bagge and Hoppe (2001).

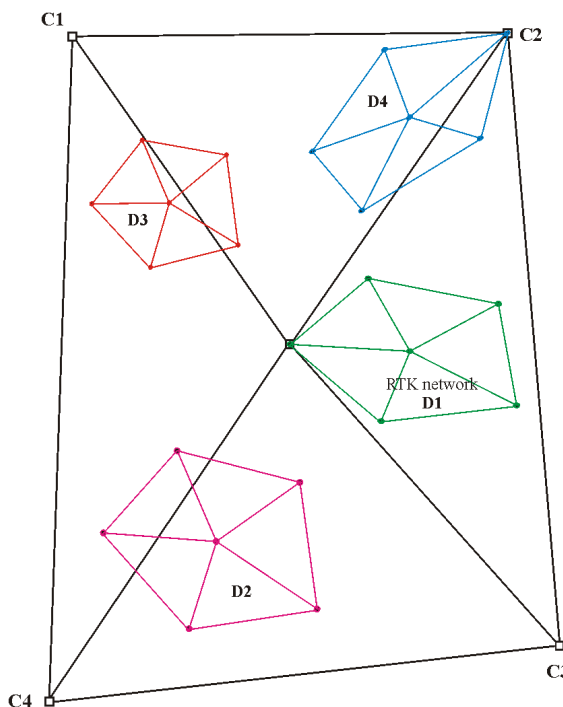

Figure 3: Integration of national (C) and regional (D) RTK networks

4. ACTIVE GPS REFERENCE NETWORKS

RTK networks not only provide a precise real time positioning service, they also realize an active reference frame. Applying the PDGPS corrections, a user directly connects to the datum represented by the reference station X_{RS} in (1) of the RTK network. Hence, the monumentation of dense geodetic control networks is no longer necessary. This aspect makes

RTK networks especially economical. Augath (1994) showed for the State Survey Authority of Lower Saxony, Germany, that the maintenance of all monumented control points and survey markers needs the highest expenditure of the Survey Authorities budget. Putting aside the legal aspects of boundary markers, such monumentations are not required if cadastral surveys are directly linked to the RTK network.

For large countries like Brazil this means, the efforts for establishing and maintaining dense control networks can be replaced by the operation of active reference networks. The transformation of the various existing networks into the new homogeneous and unified GPS based frame will remain the largest challenge, although suitable transformation strategies have already been developed. Beyond the surveying experts, the active reference frame will be especially valuable for all other GPS users in various applications (e.g. GIS, rural land management, agriculture, civil engineering, town planning, energy supply, geophysical exploration, hydrographic surveys and marine applications). For those users, mostly not familiar with different datums and frames, a single standardized reference frame will be of highest value.

5. SURVEYING APPLICATIONS OF RTK NETWORKS

Precise real time positioning in RTK networks is an effective means to link cadastral surveys to the official reference frame and to provide temporal local control points for surveys with electronic tacheometers. If signal shading is no concern, like in rural areas or many suburban districts, GPS can also be utilized for direct detailed surveying, e.g. observation of boundary signs and topographic objects. In Tab. 1 the most common applications in land surveying are listed and the suitability of rapid and real time GPS methods for such applications is assessed. Network RTK is in practically all cases advantageously applicable, as long as maximum accuracy and reliability is not demanded.

Table 1: Suitable GPS positioning methods for typical surveying applications (■ well suitable, ☞ partly suitable, ○ unsuitable)

Survey method Application	Post Processing		Real Time	
	Static, rapid static	stop&go kinematic	RTK	network RTK
Geodetic control surveys	■	☞	○	■
Network densification	■	☞	☞	■
Cadastral surveys	○	☞	☞	■
Topographic surveys	○	☞	☞	■
Large scale mapping	○	☞	☞	■
Surveying-in of buildings ¹	○	○	☞	■
Setting out	○	○	☞	■

1) in combination with electronic tacheometry

Since signal obstructions due to buildings, bridges, trees etc. occur easily and frequently in cadastral surveying the combination of GPS with conventional surveying methods is always essential. GPS alone will never completely replace terrestrial geodetic instruments. For the setting out of coordinates the use of GPS is only effective, if the real time capability, i.e. algorithms for on-the-way (OTW) ambiguity resolution, is available. Only then an immediate check in the field is possible. The OTW option is also very useful for topographic surveys or

GIS mapping, if an automatic data flow to a field computer is established. By visualising the surveyed objects over the existing data base, missing areas and objects are easily identified. Gross errors like mismatched points are also quickly to recognize.

Real time methods are also suitable for height transfers with subdecimeter accuracy. The use of identical antenna types on the reference and rover station or calibrated antennas is a prerequisite. The antenna set-up including the determination of the antenna height needs particular care. For higher accuracy requirements longer static GPS observations and extensive post processing is necessary. With GPS, only geometrically defined ellipsoidal heights and height differences can be determined. In order to derive heights related to the gravity field, a precise geoid model is required.

6. GPS REFERENCE NETWORK SET-UP

In November 2000, an active GPS reference network for precise real time positioning was operated for about three weeks in the urban area of Recife. Recife with about 2.5 million inhabitants is the 4th biggest city of Brazil. It is the capital of the north-eastern state Pernambuco. The densely populated urban area is mainly flat with two major rivers passing through and is encompassed by a higher plateau. Except the city centre and some living quarters along the coast, where high-rise-buildings obstruct GPS signal reception, the conditions for GPS surveys are good.

Four GPS reference stations (Fig. 4) were set up on top of high buildings and towers. With one exception (SOLA), all GPS antennas were mounted on concrete pillars. For station SOLA and all rover stations tripods were used. The central reference station UFPE was located on the highest building on the campus of the Universidade Federal de Pernambuco (UFPE). Also included was the station RECF of the RBMC network that is placed on the library tower of the university campus.

The set-up for each station included a geodetic dual-frequency GPS receiver with an absolute calibrated geodetic antenna, an UHF radio modem with antenna, and a PC with OS/2 operating system running the GNSMART software modules. Power supply, no-breaks, and converters completed the equipment (Fig. 5). Although each reference station could basically work as a single base for conventional RTK positioning the main task was to generate PDGPS corrections in RTCM format and transmitting them to the central reference station.

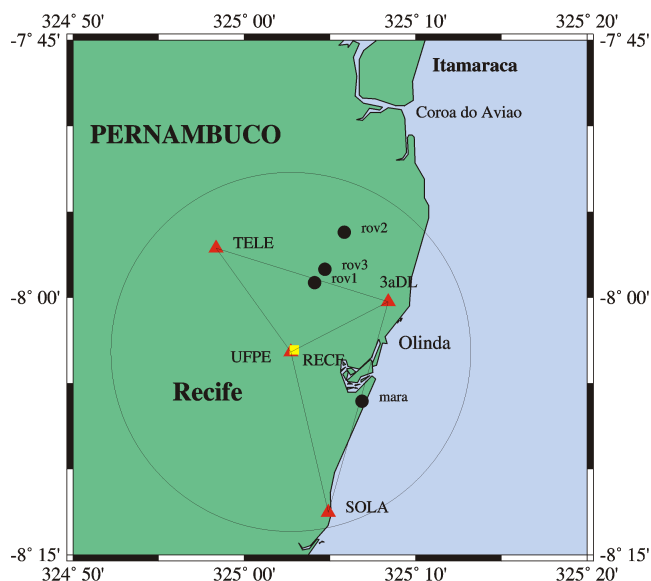

Figure 4: GPS reference network Recife with the coastline of Pernambuco. The RBMC station (square), reference sites (triangles), and permanent rover (circles) are plotted. The large circle with 20 km radius represents an hypothetical area of equal accuracy of better than 5 mm.

Together with the corrections computed for the central reference station UFPE the PDGPS corrections received by UHF radio link (Fig. 6) were processed with the real time multi-station algorithm implemented in the GNNET module. At first, cycle slips have to be detected and eliminated before the ambiguities can be estimated together with the complete state vector in a simultaneous dual-frequency adjustment. Following the state space estimation, the representation of the error states by simple mathematical means is required. The spatial variations of the residuals are approximated by a low-order surface model, and the coefficients of this model (area correction parameters, FKP) are disseminated in the RTCM message type 59 together with the carrier phase corrections (RTCM message type 20/21) and all other obligatory RTCM messages (Wübbena, Bagge, Schmitz 2001).

The PDGPS corrections including the network coefficients were broadcasted via VHF radio. Because of the high elevation of the VHF radio transmitter and the fairly flat topography of Recife, corrections could be received in almost all tested parts of the city. With VHF waves distances of 70 km can be reached, so that the university building is an ideal location for broadcasting corrections in a permanent PDGPS service.

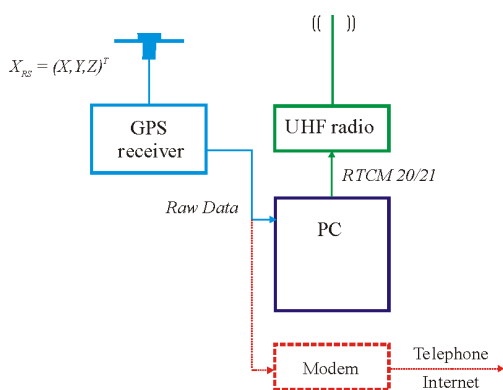

Figure 5: Reference station equipment

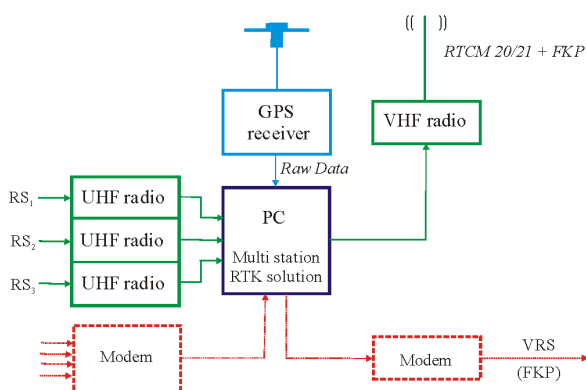

Figure 6: Hardware set-up for the RTK network processing centre

In contrast to the set-up described before it is also common to operate the peripheral reference sites in such small networks in a passive mode. The GPS data are read from the receivers serial interface and directly transmitted to the processing centre using a telephone or internet connection. Neither a computer nor a radio transmitter is required at the peripheral reference station so that the hardware costs are reduced.

Broadcasting RTCM corrections using VHF or other radio frequencies has the advantage that the number of users is unlimited. But it can be difficult to cover the whole area reliably with corrections, depending on the topography and on the extension of the network. Cellular phones are an alternative, if a good communication infrastructure ensures the reception of corrections in all parts of the network. Although this assumption holds for Recife and most of the other urban areas of Brazil, the mobile phone system did not allow data transfer during the measurement campaign.

7. UTILIZING RTK NETWORKS FOR CADASTRAL SURVEYS

Real time PDGPS surveys are carried out in the field using an equipment comparable to reference stations shown in Fig. 5. The major differences are that the VHF radio in this case receives corrections, that a geodetic dual-frequency GPS receiver is not necessary albeit recommended, and that all the hardware needs to be sturdy, compact and portable. The GPS antenna is usually mounted on a pole with the computer attached to it.

The computer can be either a notebook with GNSMART software, or a typical controller with RTK capable firmware that is delivered with GPS receivers. Since RTK network corrections are packed into RTCM type 59, a decoder is needed to convert the network corrections into standardized RTCM 20/21 corrections. For best results, the processing software should be adopted to network RTK. Conventional RTK software will only yield sub-optimal results, as the algorithms are optimized for short baselines.

After successful ambiguity resolution the measurements can be continued on adjacent points as long as no cycle slips occur caused by obstructions or by tilting the antenna while in motion. With ambiguities fixed, just one epoch is in principle sufficient for a precise coordinate determination. Nevertheless it is advisable to collect a few epochs and even repeat the ambiguity fixing at least once if observing important points. A cycle slip requires a new initialisation of ambiguities which should succeed within one to three minutes.

A single coordinate determination is not reliable. As ambiguities are sometimes fixed wrong, an independent check is inevitable. For an independent measurement a sufficient change of the satellite constellation is required, which will need at least one hour between the two observations. For each measurement, careful centering and accurate determination of the antenna height is of utmost importance, since they belong to the few remaining uncontrolled error sources.

8. ANALYSIS OF MULTI STATION RTK SOLUTIONS

The analysis of results obtained during the measurement campaign in Recife starts with a comparison of single station RTK and multi station (network) RTK. For both results for the ionospheric-free solution L0 and for the LX solution are presented in Tab. 2. The LX solution has a much lower signal noise than L0, it is derived from a simultaneous dual-frequency adjustment, the processing algorithm used in GNSMART. For single station RTK also L1 and L2 solutions are given.

Table 2: Comparison of single and multi station RTK solutions

Solution:	Multi station		Single station			
	LX	L0	LX	L0	L1	L2
Constant error [mm]	8	11	3	11	12	21
Distance dependent error [ppm]	0.15	0.11	1.6	0.9	7.0	11.49

The distance dependent error of the single station solutions for L0 and LX is about ten times larger than the corresponding error for the multi station solution. With less than 0.2 ppm the distance dependency of the multi station solutions can be neglected. For a 50 km baseline, the

distance dependent error would not exceed 1 cm which is well within the specifications for cadastral surveys. Single stations solutions on the contrary will exceed such specifications beyond a baseline length of 10 km. Even worse is the result for single frequency receiver commonly used in RTK systems. For the L1 signal, a distance dependent error of 7 ppm was estimated, mainly due to the strong ionosphere in Brazil. Assuming a threshold of 2 cm, such systems could only be used for baselines up to 3 km. It should be remarked that single station RTK solution could hardly be achieved for baselines longer than 12 km. The times to fix ambiguities (TTFA) increased by 300 sec per 10 km distance, so that rapid static methods become competitive.

In Tab. 2, a constant error is listed besides the distance dependent error. This constant error includes mainly signal noise and station dependent error components like e.g. multipath. For L0, a constant error of 11 mm corresponds to the noise of the iono-free linear combination. For LX, a constant error of 2-4 mm can be expected. The much higher value for the multi station solution of LX is due to unmodelled effects in the RTK network.

The results in Tab. 2 and of the subsequent figures are derived from observations of permanent rover. In order to present statistically significant results for the accuracy, speed and reliability of RTK network positioning, a rover was set up for several hours. Some rover were placed at the edge of the network (mara) and also beyond (rov1-rov3) in order to test how far the network corrections can be extrapolated. The real time solutions for the rover were continuously recorded. Ten seconds after each successful fixing – or 15 minutes at the latest, if no fixing occurred – the rover was reset for a new solution. Due to some difficulties with the reception of RTCM corrections, the recorded GPS observations at all stations were reprocessed using the real time algorithm.

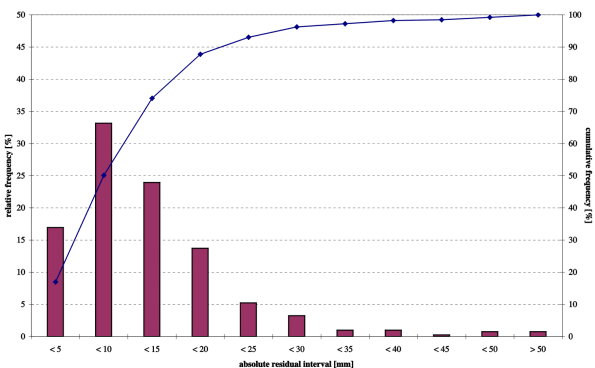
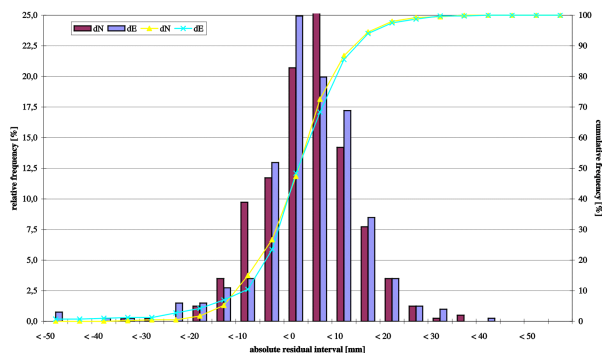

Figure 7: Positioning accuracy in the horizontal components Figure 8: Horizontal (2D) positioning accuracy

The following results are exclusively based on RTK network solutions. Station UFPE was employed as a permanent rover in the network built by the three stations 3aDL, SOLA, and TELE. The real time LX solutions are compared with a reference solution derived from post processing. Presented are results for DOY320 in GPS week 1088 (Nov 15th, 2000).

Fig. 7 shows the relative and cumulative frequency of the absolute residuals of the horizontal components, classified into 5 mm intervals. Assuming a threshold of 2 cm for cadastral surveys, more than 95% of all 404 solutions will meet this specification. The resultant of the horizontal components is plotted in Fig. 8. More than half of the residuals is smaller than 1

cm and 90% is within the threshold of 2 cm. These results prove that even under the unfavorable ionospheric conditions in Brazil multi station RTK is a powerful GPS positioning method for cadastral surveys.

The residuals in the height component are much more spread over the intervals (Fig. 9). Despite using calibrated antennas, only 50% of the height residuals are below 2 cm, but at least 90% are smaller than 5 cm. Gross errors of more than 10 cm occur in less than 1% of all solutions.

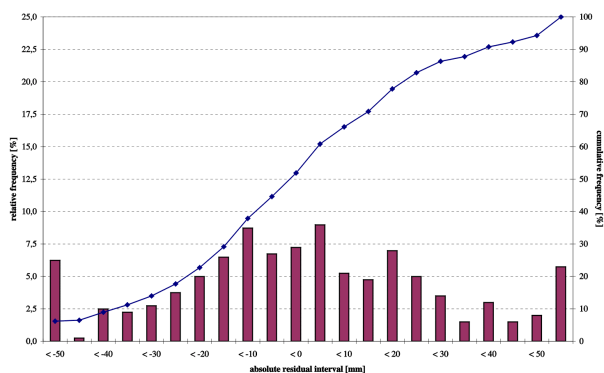

Figure 9: Vertical positioning accuracy

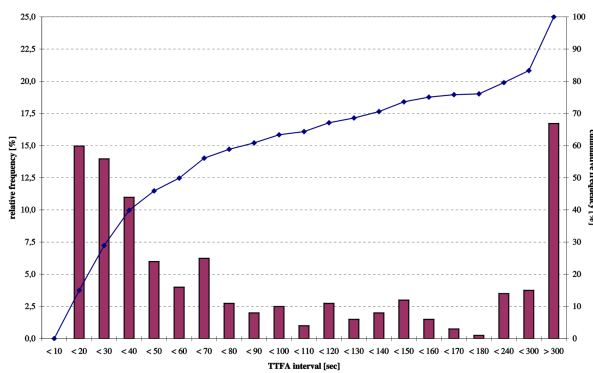

Figure 10: Time to fix ambiguities (TTFA)

Besides the accuracy also the time for obtaining a solution is an important criterion for real time positioning. It depends on the speed of the ambiguity resolution and is expressed as TTFA (Time to Fix Ambiguities) value. Divided into 10 sec intervals, the TTFA values are shown in Fig. 10. More than half of all solutions are obtained in less than 60 sec, 80% are successful within 3 min. Solutions that need more than 5 min (17%) are not necessarily less accurate, but the probability of a blunder increases. Hence, and for economical reasons as well, not more than 5 min should be given for the ambiguity resolution.

TTFA values do not give any information on the availability of solutions during the day. Fig. 11, showing the distribution of residuals for the horizontal and for the height component as a function of observation time, exhibits gaps soon after sunrise (5:30 a.m.) and sunset (6 p.m.), when high gradients of ionospheric delay occur. From sunset until midnight, the level of ionospheric activity is so high, that no network RTK solution is possible. With decreasing ionospheric activities after midnight the network software resumes its normal operation until sunrise. Another distinct period with a lower number of fixings occurs in the afternoon when the highest level of electron content is reached.

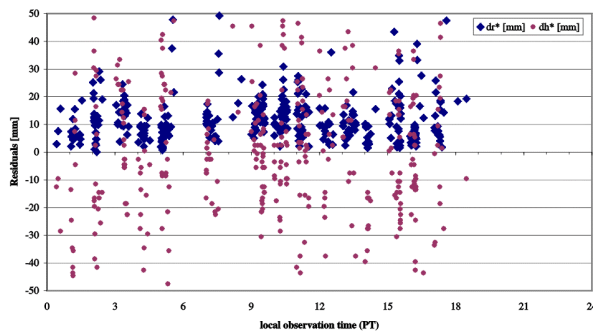

Figure 11: Availability and accuracy of RTK network solutions depending on local observation time

The influence of the equatorial ionosphere as seen in Fig. 11 needs closer examination. For the sunset period on DOY 320 the double difference range residuals of the iono-free signal

L0 and of the ionospheric signal LI are plotted. After sunset at 6 p.m. (9 p.m. UTC), the ionospheric residuals LI (Fig. 12) increase drastically and variations of up to 1 m corresponding to 50 ppm within few minutes occur. The filter algorithm trying to model the atmospheric influences can hardly follow these vigorous variations. In the worst case, the receiver's phase lock loop can no longer track the carrier phases. Cycle slips occur frequently under such circumstances. This in turn prevents a successful ambiguity resolution. From the residuals of the L0 signal (Fig. 13) the advantages of dual frequency observations can be seen. The ionospheric delay is noticeable as an increased noise after sunset. But the L0 signal is nevertheless indispensable for modelling the ionospheric delay.

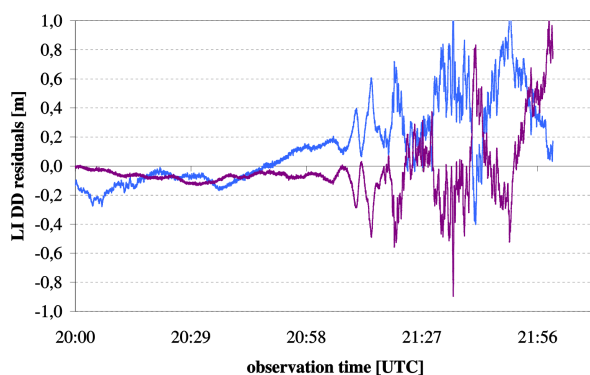

Figure 12: LI DD-Residuals during sunset (UFPE-TELE (15 km), SV 3-1, 3-31)

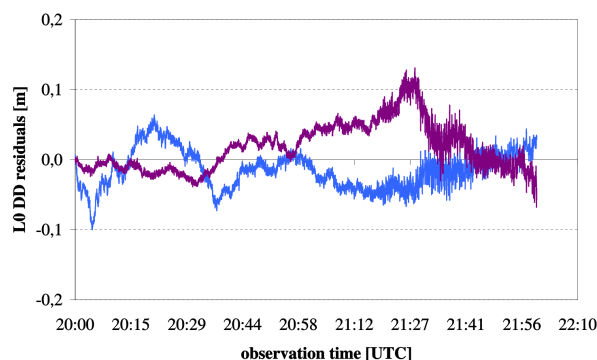

Figure 13: L0 DD-Residuals

9. CONCLUSIONS

Cadastral and other detailed surveys require positioning methods that supply accurate, reliable positioning solutions in short time. GPS is such a highly flexible tool, able to provide cm accuracy in less than one minute over distances of few tens of kilometers, if an active reference network is employed. For large nations like Brazil it is impossible to provide a PDGPS service all over the country. It is more economical instead to cover only densely populated areas and important economic regions. A concept for such RTK networks and how they can be linked was introduced. Although the set-up of RTK networks needs quite an effort, it is of utmost importance for all users requiring precise real time positioning. The potential users are not only the surveying experts but come also from various other applications.

The remaining challenges regarding RTK networks concern standards for network corrections and some technical questions, especially related to the dissemination of corrections. A reliable data communication infrastructure is needed. The cellular phone system should be used as soon as it allows data communication. In addition to the presented system a monitoring system is indispensable, that detects malfunctions and failures reliably and sends appropriate integrity warnings to the users.

REFERENCES

- Augath, W. (1994): Stand und Entwicklungstendenzen des GPS-Einsatzes in der Landesvermessung. ZfV 119, 233-240
- Böder, V., Menge, F., Seeber, G., Wübbena, G., Schmitz, M. (2001): How to Deal with Station Dependent Errors – New Developments of the Absolute Calibration of PCV and Phase-Multipath with a Precise Robot. ION GPS 2001
- Dai, L., Han, S., Wang, J., Rizos, C. (2001): A Study on GPS/GLONASS Multiple Reference Station Techniques for Precise Real-Time Carrier Phase-Based Positioning. ION GPS 2001
- Fotopoulos, G. 2000: Parameterization of DGPS Carrier Phase Errors Over a Regional Network of Reference Stations. UCGE Report 20142, Dept. of Geomatics Engineering, Univ. of Calgary
- Fröhlich, M. (1994): The High Precise Permanent Positioning Service (HPPS) in North Germany - Test and First Results. 3rd Int. Conf. on Differential Satellite Navigation Systems, London
- Menge, F., Seeber, G., Völksen, C., Wübbena, G., Schmitz, M. (1998): Results of Absolute Field Calibration of GPS Antenna PCV. ION GPS 1998, 31-38
- Muellerschoen, R.J., Bar-Sever, Y.E., Bertiger, W.I., Stowers, D. (2001): NASA's Global DGPS for High-Precision Users. GPS World, 1, 14-20
- Seeber, G. (1993): Satellite Geodesy: foundations, Methods, and Applications. de Gruyter, Berlin
- Townsend, B., Lachapelle, G., Fortes, L.P., Melgård, T.E., Nørbech, T., Raquet, J. (1999): New Concepts for a Carrier Phase Based GPS Positioning Using a National Reference Station Network. ION NTM 1999, San Diego
- Vollath, U., Buecherl, A., Landau, H., Pagels, C., Wagner, B. (2000): Multi-Base RTK Positioning Using Virtual Reference Stations. ION GPS 2000, 123-131
- Wanninger, L. (2000): Präzise Positionierung in regionalen GPS-Referenzstationsnetzen. DGK, C 508, München
- Wübbena, G., Bagge, A., Seeber, G., Böder, V., Hankemeier, P. (1996): Reducing Distance Dependent Errors for Real-Time Precise DGPS Applications by Establishing Reference Station Networks. Proc. ION GPS 96, Kansas City
- Wübbena, G., Bagge, A., Hoppe, T. (2001): Zur Bildung von Subnetzen in der Referenzstationsvernetzung mit GNSMART. <http://www.geopp.de> (Internal Report)
- Wübbena, G., Bagge, A., Schmitz, M. (2001): RTK Networks based on Geo++ GNSMART – Concepts, Implementation, Results. ION GPS 2001
- Wübbena, G., Willgalis, S. (2001): State Space Approach for Precise Real Time Positioning in GPS Reference Networks. Internat. Symp. On Kinematic Systems in Geodesy, Geomatics and Navigation (KIS2001), Banff, 72-79

BIOGRAPHICAL NOTES

Dr. Claudia P. Krueger received her degrees in Geodesy from the Universidade Federal do Paraná in Curitiba. As a Ph.D. student, she studied one and a half year at the Institut für Erdmessung, Universität Hannover. In 1996 she was appointed as Professor at the Departamento de Geomatica (UFPR), where her research and teaching is concerned with GPS positioning especially for marine applications.

Dr. Verônica M.C. Romão works in the field of satellite positioning since 1982, after studying Geodesy at the UFPE in Recife and at the UFPR in Curitiba. Dr. Romão spent four years at the Institut für Erdmessung, where she received her Ph.D. in 1995. She is Professor at the Departamento de Engenharia Cartográfica at UFPE in Recife since 1984. Her research interest focuses on the application of GPS for cadaster and GIS.

Dr. Günter Seeber has been Professor at the Institut für Erdmessung since 1973, where he teaches satellite geodesy, geodetic astronomy, and marine geodesy. He has specialized in satellite positioning techniques since 1969 and has published several scientific papers and books in the field of satellite and marine geodesy.

Stefan Willgalis received his Dipl.-Ing. in Geodesy from the Universität Hannover, Germany in 1995. Currently employed as research associates in satellite positioning at the Institut für Erdmessung, the research of Stefan Willgalis focuses on precise real time GNSS positioning.