

Prices
2017

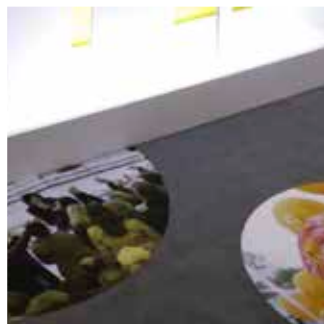

Fair Products and Services

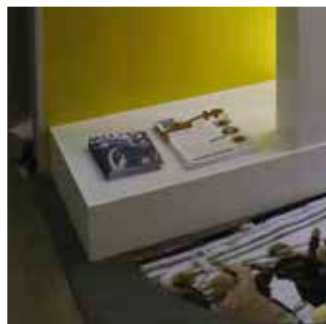
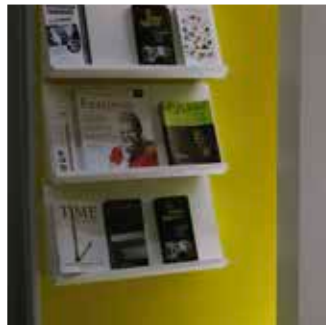
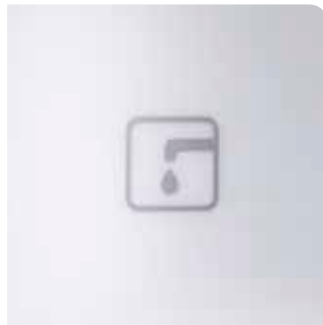
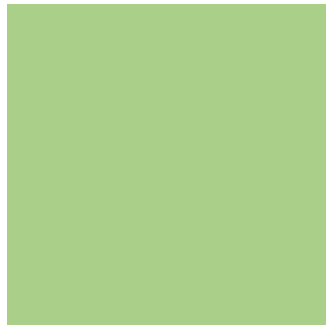
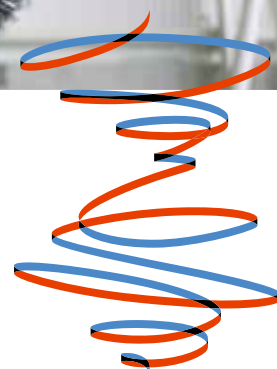
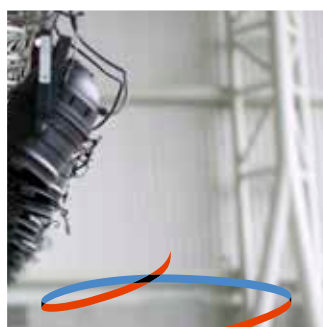

Messukeskus

CONTENTS



Place your orders
conveniently:
emessukeskus.com

2017

FAIR PRODUCTS

AV AND TELE- COMMUNICATION SERVICES

OTHER SERVICES

RENTAL AND PAYMENT TERMS

Fair products and services

FAIR PRODUCTS

Design stands	3
Ready-made stand	5
Profile constructions	5
Standard constructions	7
Carpets and flooring	9
Furniture: furniture sets	10
Furniture: desks and cabinets	11
Furniture: tables and chairs	12
Furniture: shelves and brochure stands	13
Furniture: other	14
Lighting	15
Electrics	16
Graphics services	18

AV AND TELECOMMUNICATION SERVICES

AV services	19
Data Communications	20

OTHER SERVICES

Collecting leads at your stand	20
Suspensions	21
Cleaning	22
Plants and flowers	23
HPAC Services	24
Logistics services and storage	25
Security services	26
Conference services	27
Exhibition catering services	27
Hotel services	27

RENTAL AND PAYMENT TERMS

28

DESIGN STANDS

We will refine your fair idea into a functional stand

The design of a functional fair stand always starts from the goals set for participation at the fair. A stand that reflects your corporate image best supports the achievement of your goals. We will put our professional skills to use in designing and building your stand and take care of all practical matters for you.

The designers of Messukeskus are uniquely placed to follow Finnish and international trends in various fields. They will also be able to offer you the latest ideas for new solutions that will give your ideas concrete shape.

Professional carpenters and a number of different structural systems are available: a straightforward standard structure, a conventional aluminium profile and an elegant Molto structure. We take care of everything to do with your stand structures from furnishing, lighting and AV technology to suspension, graphics and decoration.

Our visualisation techniques feature the latest technology, which means that you will always have illustrations of stand designs. The designer will take care of all contacts and orders from partners while you can concentrate on establishing contact with your customers and deciding on the message you wish to communicate to them.

Get in touch with us, and we will join forces to create a framework for achieving your goals: design@messukeskus.com

WE OFFER easy
turnkey solutions.

WE OFFER
a comprehensive
service tailored
to your needs.





An impressive stand attracts visitors. We will design a comprehensive solution to support your goals cost-effectively.



READY-MADE STAND

By ordering a ready-made stand is an easy way to get basic constructions to your stand.

The wall element system can be chosen between standard elements and profile system. On standard element system the walls and fascia are made of white painted hardboard. It is possible to attach light items with adhesives, screws and nails. Remember to remove these after the fair.

On profile system the wall material consists of aluminium-profile frame and white board. It is possible to attach light items using adhesives. Remember to remove these after the fair. Also decoration hooks can be used for hanging posters and pictures. Turn-key stand includes carpet tiles. Turn-key stand includes spotlights, socket and basic charge for electricity. The amount of spotlights according to the size of the stand.



VP1

Ready-made stand
Profile system 6-10 m²

€81/m²

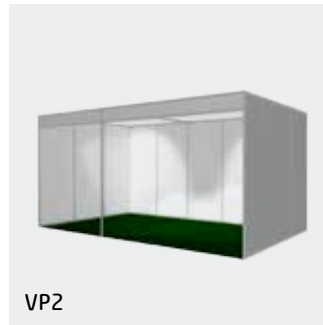

VP2

Ready-made stand
Profile system 12-21 m²

€63/m²



VP3

Ready-made stand
Profile system 24-36 m²

€52/m²



VV1

Ready-made stand
Standard system 6-10 m²

€81/m²

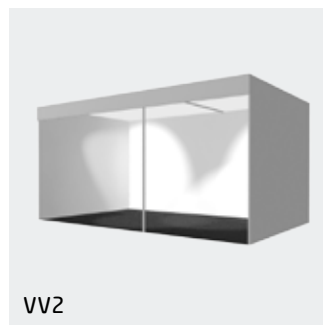

VV2

Ready-made stand
Standard system 12-21 m²

€63/m²



VV3

Valmisosasto
Standard system 24-36 m²

€52/m²

PROFILE CONSTRUCTIONS

Our profile systems come in several widths, heights and shapes. The basic material is an aluminium-profile frame and white board. Options include six basic colours from colour palette. Acrylic boards and board with colour coating can also be ordered separately. We offer special shades such as your company's own colours, by agreement. The exact measures of the profile system can be found on attachment below. Items can be attached to profile structures using adhesives, which must be removed afterwards, or hooks.

Profile system and standard wall elements are separate structures, which cannot be combined.

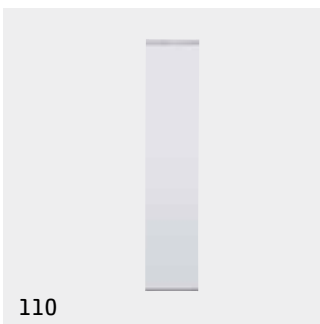

110

Partition element
Profile system 100x250 cm

€46

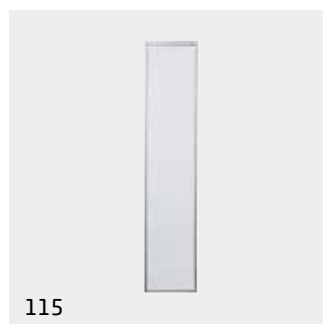

115

Partition element
Profile system 50x250 cm

€41



141

Partition element
With window, transparent 100x250 cm

€97



144

Partition element
With window, transparent 50x250 cm

€84



160

Partition element
Curved, r 100 x h 250 cm €106



161

Partition element
Curved, r 50 x h 250 cm €92



163

Partition element
Curved with transparent window, r 100 x h 250 cm €136



166

Partition element
Curved with transparent window, r 50 x h 250 cm €114



169

Door element with lock
Profile system r 100 x h 250 cm €87



171

Folding door element with lock
Profile system 100x250 cm €95



172

Folding door element
With lock and windows, profile system, 100x250 cm €95



173

Curtain element
Profile system 100x250 cm €56



180

Fascia
Profile system, h 30 cm €21/m



181

Fascia
Profile system, curved r 100 x h 30 cm €39



182

Fascia
Profile system, curved r 50 x h 30 cm €34



190

Pole
Profile system h 250 cm €10



191

Support beam
Horizontal, profile system €9/m



VAR101

Storage
1 m², profile system 200 €



VAR102

Storage
2 m², profile system €246



VAR103

Storage
4 m², profile system €292



1501

Coloured wall board
Black €25

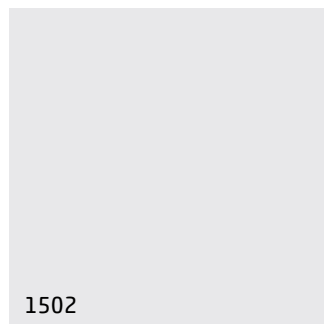

1502

Coloured wall board
Light grey €25

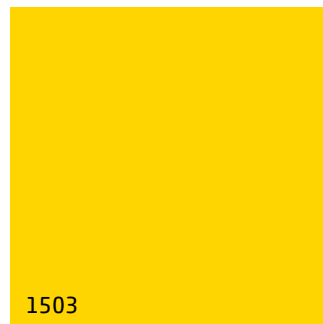

1503

Coloured wall board
Yellow €25

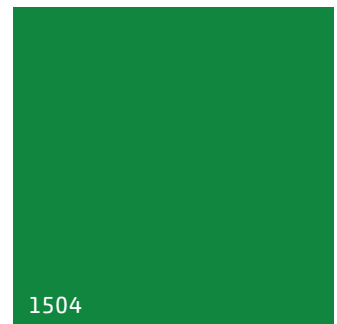

1504

Coloured wall board
Green €25



1505

Coloured wall board
Blue

€25



1506

Coloured wall board
Red

€25



1521

Coloured fasciaboard
Black

€13/m

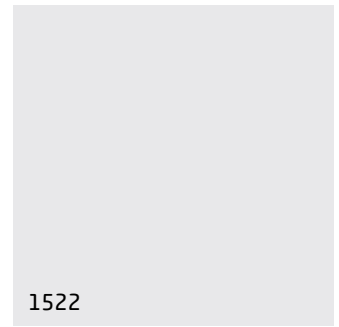

1522

Coloured fasciaboard
Light grey

€13/m



1523

Coloured fasciaboard
Yellow

€13/m



1524

Coloured fasciaboard
Green

€13/m



1525

Coloured fasciaboard
Blue

€13/m



1526

Coloured fasciaboard
Red

€13/m

STANDARD CONSTRUCTIONS

Standard wall elements are made of white hardboard. Light items can be attached using adhesives, screws or nails, which must be removed afterwards. We also paint standard wall elements according to customers' wishes for an extra charge with standard colour or special colour.

Profile system and standard wall elements are separate structures, which can not be combined.



220

Wall element
Standard system 100x250 cm

€46



225

Wall element
Standard system 50x250 cm

€41



230

Door element with lock
Standard system 100x250cm

€87



231

Folding door element with lock,
Standard system 100x250cm

€95



232

Curtain element
Standard system 100x250cm

€56



240

Fascia
Standard system h 30 cm

€21/m



250

Pole
Standard system h 250 cm

€10

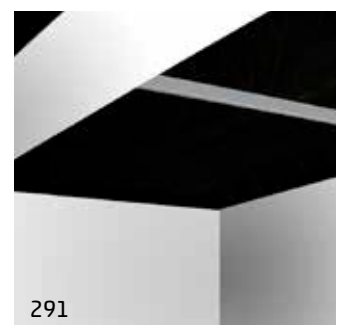

291

Support beam
Horizontal, standard system

€9/m



Storage
1 m², standard system €200



Storage
2 m², standard system €246



Storage
4 m², standard system €292

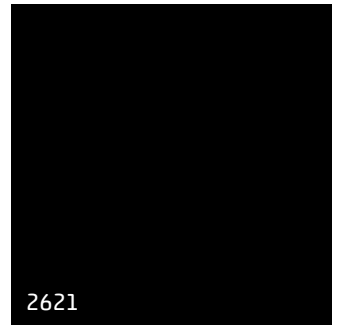

Painting of wall element
Black €45



Painting of wall element
Grey €45



Painting of wall element
Yellow €45

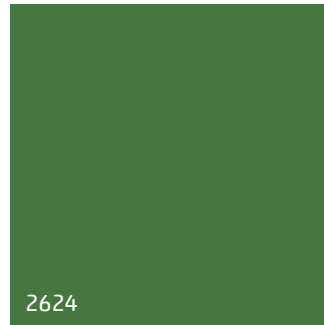

Painting of wall element
Green €45



Painting of wall element
Blue €45



Painting of wall element
Red €45



Painting with special colour
Element surface €57

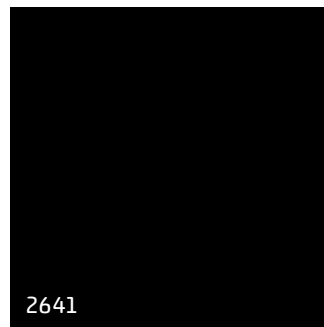

Painting of fascia board
Black €17/m

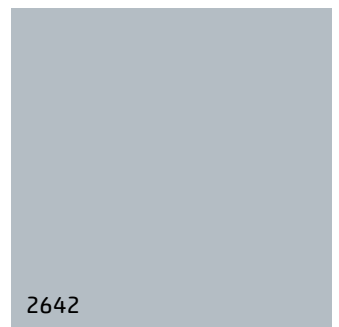

Painting of fascia board
Grey €17/m

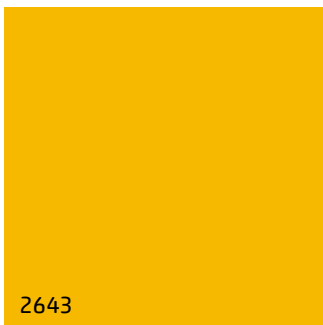

Painting of fascia board
Yellow €17/m

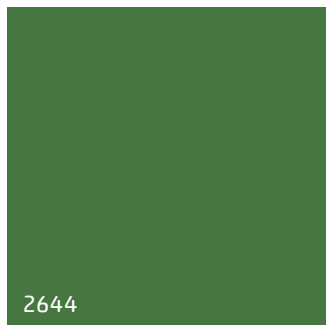

Painting of fascia board
Green €17/m

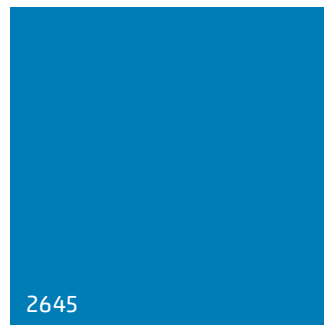

Painting of fascia board
Blue €17/m

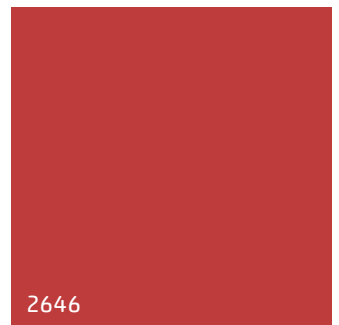

Painting of fascia board
Red €17/m



Painting of fascia board
With special colour €27/m

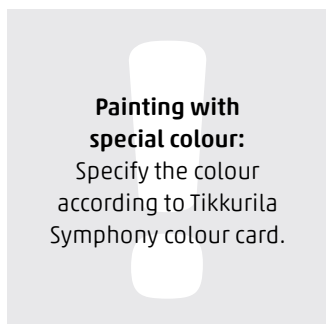

CARPETS AND FLOORING

Our range includes several colors of carpet tiles and carpet rolls. Carpet tiles are an ecological solution, they are reused after the fair. Prices include installation, rent and removal. Price for carpet tiles also include one vacuum cleaning after installation and price for carpet roll include removal of plastic cover prior to fair opening. For over 100 sqm carpet or other flooring material, ask for an offer.

The raised floor enables wiring and plumbing anywhere on you stand. The surface can be covered with various coating. Maximum floor load 1,000 kg/m² (static). Can be used with spot loading in special cases.



370
Dark grey
Carpet tiles €8,60/m²

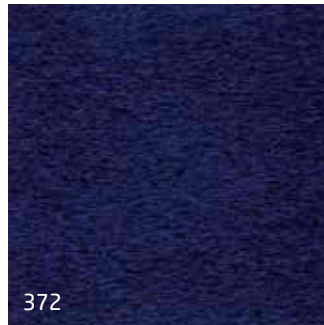

372
Blue
Carpet tiles €8,60/m²



373
Red
Carpet tiles €8,60/m²

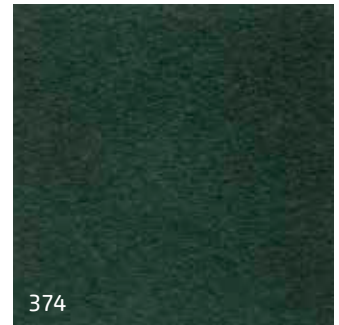

374
Green
Carpet tiles €8,60/m²



355
Dark grey, mottled
Carpet roll €9,80/m²



356
Cardinal red
Carpet roll €9,80/m²

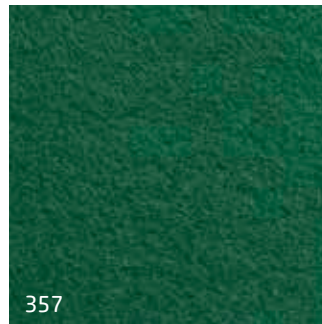

357
Dark green
Carpet roll €9,80/m²



358
Violet
Carpet roll €9,80/m²



359
Turquoise
Carpet roll €9,80/m²



376
Brown
Carpet roll €9,80/m²



377
Fuchsia
Carpet roll €9,80/m²



378
White
Carpet roll €9,80/m²



379
Yellow
Carpet roll €9,80/m²

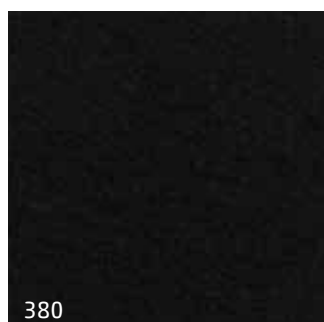

380
Black
Carpet roll €9,80/m²

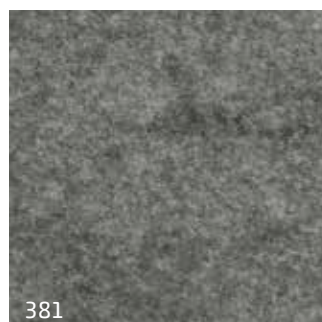

381
Grey
Carpet roll €9,80/m²



382
Blue
Carpet roll €9,80/m²



383

Red
Carpet roll €9,80/m²



384

Green
Carpet roll €9,80/m²



385

Beige
Carpet roll €9,80/m²



387

Dark blue
Carpet roll €9,80/m²

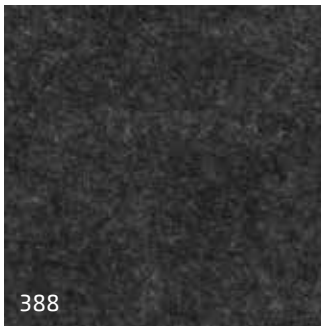

388

Graphite grey
Carpet roll €9,80/m²



389

Orange
Carpet roll €9,80/m²



386

Plastic cover €1,60/m²

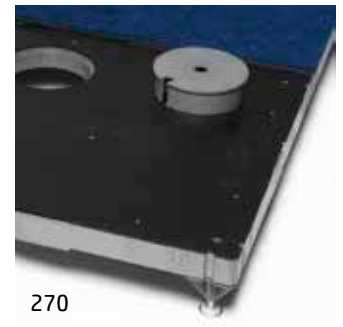

270

Raised flooring 23 €/m²
500 x 500 x 40 mm, h 80-120 mm



271

Aluminium edging strip €24/m
And black surround board



5702M

Bütetec stage €65/pc
100x200cm



5710M

Stage Dex stage €70/pc
100x200cm

FURNITURE SETS

Remember to send the drawing specifying the location of the furnishing at your stand. You can send the drawing from stand info page, upload stand layout. The prices for furnishing cover delivery to the stand and returning.



KAL01

Bar table set €138
337 Bar table, 338 Bar stool 2 pcs



KAL02

Premium bar table set €212
397 Bar table Inno Select,
398 Bar stool Inno Select 2 pcs



KAL03

Sales set €237
321 Information desk, 338 Bar stool 2 pcs,
3191 Brochure stand



KAL04

Sales set plus €417
3223 Desk combination F, 398 Bar stool
Inno Select 2 pcs, 3191 Brochure stand



KAL05

Negotiation set €103
333 Table, 336 Chair Artek Kiki 4 pcs



KAL06

Premium negotiation set €292
396 Table, 399 Chair 4 pcs



KAL07

Presentation set €248
323 Glass display cabinet,
338 Bar stool 2 pcs, 3191 Brochure stand



KAL08

Presentation set plus €459
3604 Vitrine cabinet, 323 Glass display cabinet,
338 Bar stool 2 pcs, 3191 Brochure stand

**FURNITURE:
DESKS AND CABINETS**

Remember to send the drawing specifying the location of the furnishing at your stand.
You can send the drawing from stand info page, upload stand layout. The prices for furnishing cover delivery to the stand and returning.



312

Product display cabinet €70
103 x 53 x h 70 cm



314

Product display table, €50
With boards on three sides,
103 x 53 x h 70 cm



315

Display cabinet with lock, €50
95 x 35 x h 70 cm



3201

Reply card box, €50
53 x 53 x h 100 cm



3205

Reply card box, €28
33 x 33 x h 30 cm



321

Information desk with doors, €95
103 x 53 x h 100 cm



323

Glass display cabinet, with lock €106
103 x 53 x h 100 cm

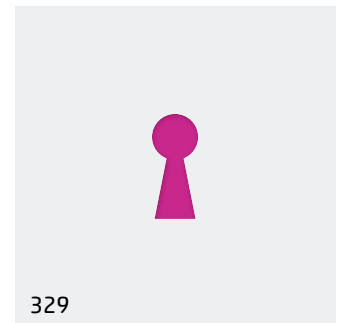

329

Lock to door, €16
Available for products 312, 321, 323, 3211,
3212, 3213, 3231, 3232, 3233



3604

Glass display cabinet, €211
With lock and light, 103 x 53 x h 182 cm



3211

Desk combination A, with doors, €163
Corner piece on the right,
153 x 53 x h 100 cm



3212

Desk combination B, with doors, €163
Corner piece on the left,
153 x 53 x h 100 cm



3213

Desk combination C, with doors, €235
Corner piece on both sides,
203 x 53 x h 100 cm



3260

Desk combination G, €145
Two corner pieces,
53 x 103 x h 100 cm



3231

Cabinet combination H, €167
Glass display with lock, corner piece on the
right, 153 x 53 x h 100 cm



3232

Cabinet combination K, €167
Glass display with lock, corner piece on the
left, 153 x 53 x h 100 cm



3233

Cabinet combination M, €236
Glass display with lock, corner piece on the
both sides, 203 x 53 x h 100 cm



3280

Desk combination S €141
Two corner pieces,
53 x 103 x h 100 cm



3631

Coloured furniture board €33
Black



3632

Coloured furniture board €33
Light grey



3633

Coloured furniture board €33
Yellow

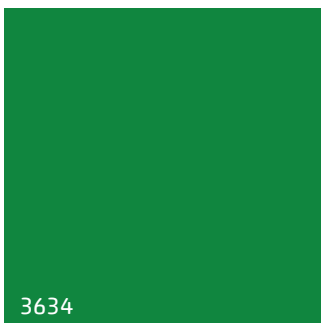

3634

Coloured furniture board €33
Green



3635

Coloured furniture board €33
Blue



3636

Coloured furniture board €33
Red

Note!
Coloured furniture boards can
be ordered to products 312,
314, 3201, 3205, 321, 323,
3211, 3212, 3213, 3260, 3231,
3232, 3233 and 3280. Top
of furniture and possible doors
of furniture are always white.

FURNITURE:
TABLES AND CHAIRS



330

Table €35
60x120, h 70 cm



331

Table €43
70x180, h 70 cm



332

Table €35
Ø 60 cm, h 70 cm



333

Table €35
Ø 80 cm, h 70 cm



367

Table with adjustable height €43
Ø 60 cm, h 70-110 cm



368

Table with adjustable height €43
Ø 90 cm, h 70-110 cm



337

Bar table €35
Ø 60 cm, h 110 cm



396
Table
Grey Inno Select, Ø 80 cm, h 71 cm €72



397
Bar table
Inno Select, Ø 60 cm, h 109 cm €72



336
Chair
Artek Kiki €17



338
Barstool
h 80 cm €46



342
Barstool
Plank Miura €50



395
Barstool
Martela Sola €60



339
Chair
Blue €11



348
Chair
Lepo Product Viva €30

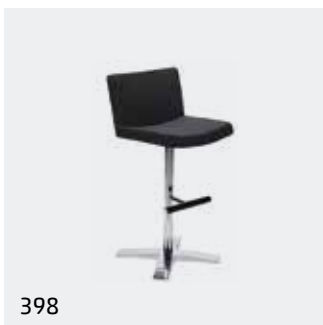

398
Barstool
Inno Select Bar €70

FURNITURE:
SHELVES AND
BROCHURE STANDS

Remember to send the drawing specifying the location of the furnishing at your stand. You can send the drawing from stand info page, upload stand layout. The prices for furnishing cover delivery to the stand and returning.



3101
Shelf, flat 30x100 cm profile €24



3102
Shelf, flat 30x100 cm standard €24



3111
Shelf, sloping 30x100 cm profile €24

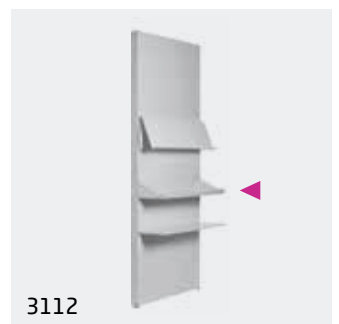

3112
Shelf, sloping 30x100 cm standard €24



3121

Shelf, sloping 30x100 cm profile, 60° €24



3122

Shelf, sloping 30x100 cm Standard 60° €24



319

Brochure stand, black (A4) €50



3191

Brochure stand, black, one-sided (A4) 50 €



354

Shelving system With 5 shelves, 80 x 30 x 188 cm €50

FURNITURE
OTHERS



154

Poster wall Two-sided, 103 x 220 cm €56



316

Coat stand €31



341

Clothes rack 100 x h 180 cm €35



343

Rope pole €12



344

Chain Plastic €3/m



349

Rope pole Black €12



350

Wall mirror Red beech, 45 x 139 cm €25



351

Hanging clothes rack €17



353

Refrigerator 120 l, 55 x 60 h 85 cm €103

LIGHTING

Lighting is an essential part of a successful stand. Proper lighting makes your stand more distinctive, enhancing the visibility of your products. From the selection of fittings you will find the suitable lighting solution. The price for lighting devices includes rental for the whole exhibition, installation and dismantling.



409
Metal halide spotlight, 35 W CDM-TC, incl. busbar €30



410
Spotlight, Bristol (To profile structures) 300 W 230V €52



413
Ledspotlight with brace For profile structures €38



420
Metal handle light, 35 W CDM-TC Incl. busbar €30

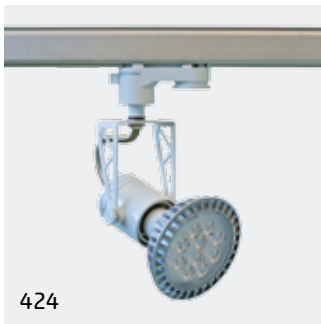

424
LED spotlight, 15 W Incl. busbar €38

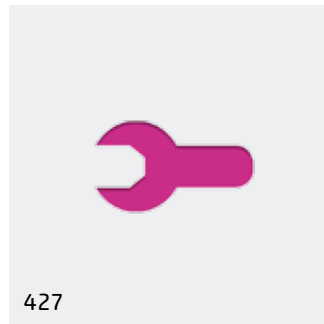

427
Busbar 3-phase Nokia XTKR 1,5-3,5 m €52



430
Metal halide ceiling spotlight 250 W Ø 48 cm, h 53 cm, Not possible in halls 1 and 7 €191



433
Metal handle light, 70W Incl. busbar €55

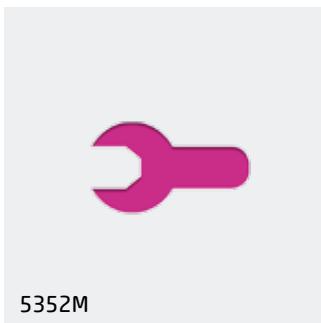

5352M
Truss suspension point €200 (Suspension points always require a chain hoist, which is not included in the price)



5361M
Electrical chain hoist €125

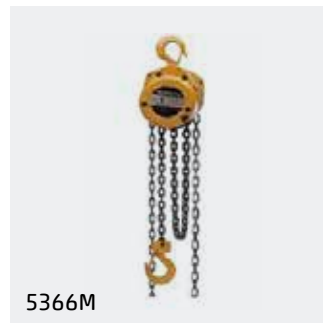

5366M
Manual chain hoist €65



5372M
Truss €30 (The price includes installation and dismantling. The price does not include struss suspension points or chain hoists.)

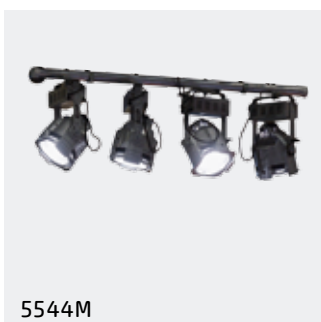

5544M
Light bar for truss Width 150 cm, 4 x metal halide 150W €280



55601M
Truss light package with 2-4 m line 4 metal halide lamps €850



55602M
Truss light package with 4-6 m line 6 metal halide lamps €990



55603M
Truss light package with 6-8 m line 8 metal halide lamps €1280



55604M

Truss light package with 8-10 m line €1600
12 metal halide lamps



55605M

Truss light package with 10-12 m line €1920
14 metal halide lamps



55606M

Truss light package with 12-14 m line €2240
16 metal halide lamps



55607M

Truss light package with 14-16 m line €2400
18 monimetallivaloa



55608M

Truss light package with 16-20 m line €2800
24 metal halide lamps



55609M

Trussframe and lighting €2200
10 spotlights



55610M

Trussframe and lighting €2700
18 spotlights



55611M

Trussframe and lighting €3100
26 spotlights



55612M

Trussframe and lighting €3600
32 spotlights

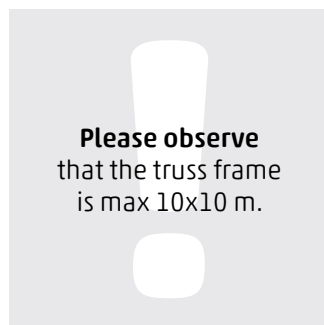

Please observe
that the truss frame
is max 10x10 m.

ELECTRICS

All stand solutions ordered from Messukeskus include socket 16A 230V (3,6kW) and energy consumption. Check the power consumption requirement of the electrical equipment to be used at the stand. All the sockets include energy consumption.

Note! For safety reasons, it is not allowed to connect lighting to sockets for steady-state current.



441

Socket €146
Schuko, 16A 230V, 3,6kW



443

Power socket €312
16 A 400 V, 10 kW



444

Power socket €498
32 A 400 V, 19 kW



445

Power socket €735
63 A 400 V, 39 kW

SOCKETS FOR OUTDOOR USE



446

Power socket 125 A 400 V, 50 kW
(Note! 80 A fuse) €796



465

Socket for outdoor use
16A 230V 3,6 kW €217



466

Socket for outdoor use
16A 400V 10 kW €399



467

Socket for outdoor use
32A 400V 19 kW €615



468

Socket for outdoor use
63A 400V 39 kW €910



469

Socket for outdoor use
125A 400V 50 kW €982

SOCKETS FOR STEADY-STATE CURRENT



442

Socket, 230 V,
0,5 kW, for a refrigerator (24h) €68



474

Socket
16 A 230 V, 3,6 kW (24h) €235



475

Power socket
16 A 400 V, 10 kW (24h) €400



476

Power socket
32 A 400 V, 19 kW (24h) €576

SOCKETS DROPPED FROM CEILING

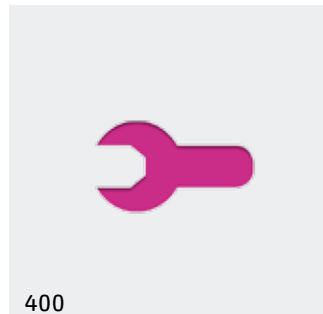

400

Socket dropped from hall ceiling €100
First drop

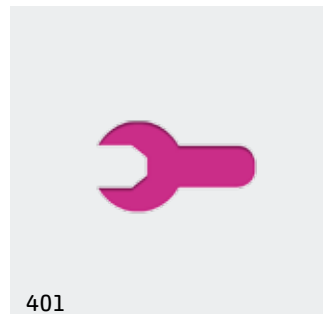

401

Socket dropped from hall ceiling €50/pc
Additional drops on the same stand / pcs

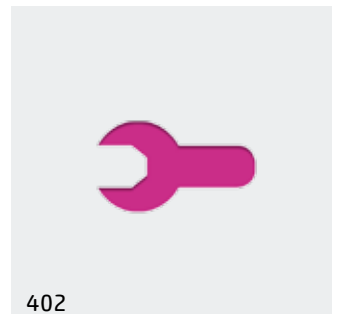

402

Socket dropped from hall ceiling €350
in hall 7, first drop

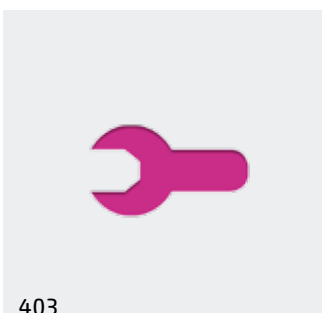

403

Socket dropped from hall ceiling €175/pc
in hall 7, additional drops on the same
stand/pcs

Please observe,
that the electrical
installation work does
not include sockets.
The price is for work,
so please be sure to
order sockets and other
equipment separately.

GRAPHICS SERVICES

Visualize your corporate image and exhibition goals.

Our graphic production unit at Messukeskus will assist you with production decisions and material choices. We offer custom print production on a range of materials such as textile, tape, paper and board. We also offer post-production services such as lamination, priming, and framing.

Turning ideas into products with skilled graphic design. We can provide you the visual design and layout work for press-ready print and digital needs. We are happy to help with any design or material questions. Get in touch!

For more information and pricing, please contact:
eva.jokivuori@messukeskus.com / +358 50 573 3937.



ST021

Banderol €75/m²
1-sided, fabric



ST022

Banderol €120/m²
2-sided, fabric



ST142

Posters €82
70 x 100 cm



ST210

1-colour dyed sticker taped to the fascia board €70/m
h 21,2 cm



ST211

Printed 4-color sticker taped to the fascia board €80/m
h 21,2 cm



ST220

4-color printed fascia board €130/m



ST252

Large images and graphics €245/m
printed on Kapa-board, 1 m x 2,5 m

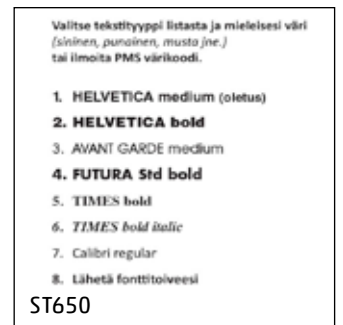

ST650

Fascia text €4,30/letter
h 140 mm



ST660

Fascia logo €100



ST051

Multicolor sign €120
70 x 100 cm



ST232

Printed front and side panels €268
To desk no 321



ST234

Printed front panel €268
Curved, to desk no 3260



ST236

Printed front panel €405
Curved, to desks no 3211, 3221, 3212, 3222



ST238

Printed front panel €448
Curved, to desks no 3213, 3223

AV SERVICES

Suomen Videoviestintä SVV is the leading expert in AV technology in Finland. SVV is a reliable partner when you need to enlist a professional. We handle all our commissions with expertise and know-how that comes from long experience. We offer a complete package. Our job is to plan and create complete AV solutions. We rent out AV equipment for fairs, company events, congresses, meetings and concerts all over Finland.

AV services are carried out by **Suomen Videoviestintä SVV Oy**, Messuaukio 1, FI-00520 Helsinki, tel. **+358 404 503 258**, e-mail svv.myynti@messukeskus.com, www.svv.fi.



5010M

Screen 32" FULL HD LCD €150



5020M

Screen 42" FULL HD LCD €370



5025M

Screen 46" FULL HD LCD €430

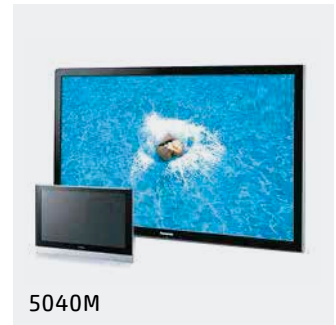

5040M

Screen 55" FULL HD LCD €550



5055M

Screen 70" FULL HD LCD €700

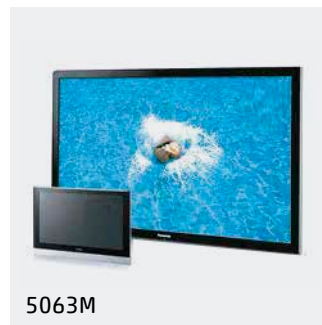

5063M

Screen 98" 4K UHD LCD €1500



5065M

Screen 103" FULL HD Plasma With floor stand €1500



5001M

Floor stand for screen €50



5040PM

Screen 55" and laptop computer -package €700



5075M

SHARP Video wall (2x2 screens) €2600

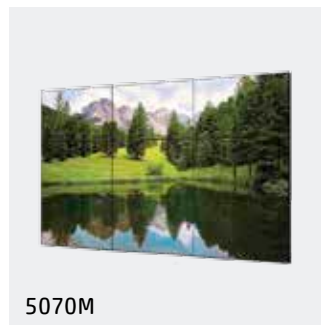

5070M

SHARP Video wall (3x3 screens) €4980



5106M

Projector BARCO RW6, 6000 ANSI LUMEN HD €1200



5112M

Projector BARCO RLM-W12, 11 500 ANSI LUMEN WUXGA €1800



5349M

USB media player €40
Plays all the standard video, image and sound file formats from a USB flash drive



5572M

PA sound system €350
Mixer, amplifier, two speakers, microphone with a cord

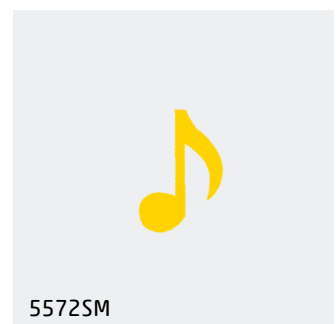

5572SM

PA sound system, small €280
Active speakers



5573M

PA system
For background music

€550



5574M

PA system
For live music

€1000



5602M

Wireless microphone

€120



5782M

Laptop

€340

DATA COMMUNICATIONS

Fixed internet connection ensures reliable connection and is recommended for the stands with points of sale terminal or when reliable internet is important to the stand functions. The fixed internet connection also includes technical support.

Please attach technical drawing where place of the cable is marked. We also provide other internet services, such as QoS and public IP addresses.



5802M

Wired internet connection
1st workstation

€290



5803M

Wired internet connection
Next workstation

€135



5811M

TV connection

€350



5812M

Extra TV connection

€50

COLLECTING LEADS AT YOUR STAND

The Catcher application enables you to collect the contact information of your fair contacts and survey their needs or to collect opinions and feedback. In addition, you can help them remember their visit to your fair stand by sending an automatic after-marketing message. The message is also an easy way of introducing your other network content to your stand visitors, and you can also attach an offer to the message if you want. After the fair, all the information collected is already in electronic format, which saves you time and trouble. The visual image of all the Catcher applications will be tailored according to the customer's wishes. At trade fairs, you can use the Catcher Pro version to read the contact information directly on the fair visitors' badges.

You can boost the after-marketing of trade fairs by registering your stand visitors by means of Procode's modern bar code and mobile technologies. Other alternatives include scanner solutions and the ContactMate mobile solution, which works on phones and tablets and generates a real-time file of the visitors to your stand. Instead of collecting tickets and business cards, you can concentrate on serving your customers. You can contact your customers without delay, even during the event, when things are still fresh in mind.



PAL101

Procode Basic

€195



PAL102

Procode Survey

€280



PAL103

Procode ContactMate
Mobile application

€250



PAL104

Procode additional scanner

€78



PAL110

Catcher M
Collect contact information

€790

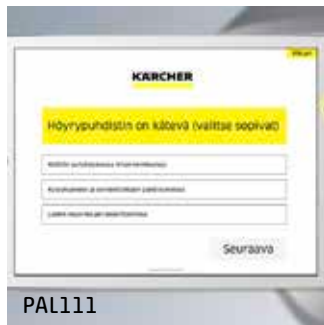

PAL111

Catcher L
Collect feedback and contact information

€990



PAL112

Catcher Pro M
Collect contact information

€990



PAL113

Catcher Pro L
Collect feedback and contact information

€1190



PAL114

iPad WiFi + Cellular

€165



PAL115

PadBuddy Floor
iPad stand

€140



PAL116

PadBuddy Desk
iPad stand

€140

SUSPENSION

Drop wires (max. load is 15 kg / suspension point) are meant for banderols, flags i.e. light decoration. Lightweight decorations can be suspended with wires from ceiling in Halls 2 – 6. They are not possible in Halls 1 and 7.

Suspension point for truss is also used for hanging other heavy items (over 15 kg/ point) from hall ceiling. Suspension point does not include chain hoist or other equipment required for hanging. These can be ordered separately. Suspension point for truss is possible in Halls 2-7. In Hall 1 truss suspensions are possible only in some parts of the hall.

Remember to attach drawings (place and height defined) as well as information on the material of suspended items. Please read the event instructions for additional advertising space and extra high constructions. For all structures over 250 cm you need approval from the Finnish Fair Corporation 45 days prior to exhibition.

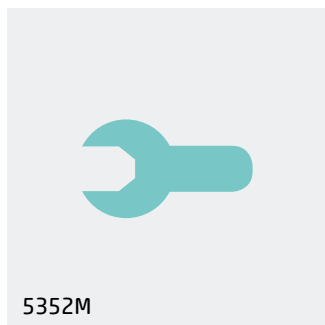

5352M

Suspension point for truss

€200



5361M

Electric chain hoist

€125

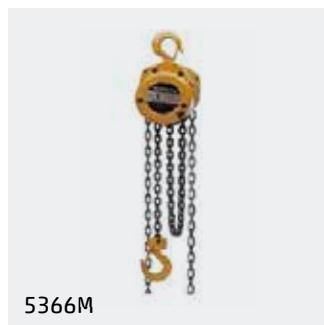

5366M

Manual chain hoist

€65



5372M

Truss

€30

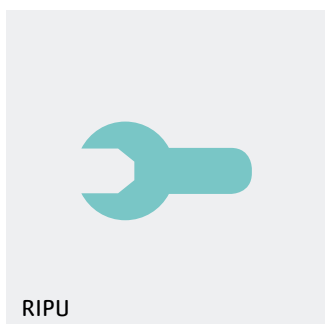

RIPU

First suspension point

€200



RIPU2

Additional suspension points

€100

CLEANING

Tidiness of the booth is an important part of the company image you are giving to fair visitors. A tidy booth is inviting and creates a positive memory of the encounter. SOL will be happy to take responsibility for the tidiness and comfort of your exhibition booth. The cleaning service includes wiping tables, vacuuming/moist wiping floors and emptying trash bins.

If we are allowed to start our cleaning before 10 p.m. on the night before the opening day, we can promise that the booth will be in the condition stated in the agreement by the time the exhibition opens.



900
Cleaning €43,69/time
 Before the opening, stands 0-60 m²



901
Cleaning €94,51/time
 Before the opening, stands 61-150 m²



902
Cleaning €167,22/time
 Before the opening, stands 151-250 m²



903
Cleaning €239,92/time
 Before the opening, stands 251-350 m²



904
Cleaning €334,44/time
 Before the opening, stands 351-500 m²



905
Cleaning €494,39/time
 Before the opening, stands 501 m²-



910
Cleaning €32,43/time
 After the exhibition day, stands 0-60 m²



911
Cleaning €75,90/time
 After the exhibition day, stands 61-150 m²

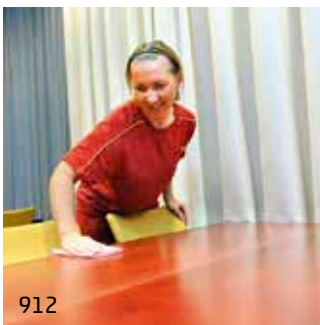

912
Cleaning €134,28/time
 After the exhibition day, stands 151-250 m²



913
Cleaning €192,67/time
 After the exhibition day, stands 251-350 m²



914
Cleaning €268,57/time
 After the exhibition day, stands 351-500 m²



915
Cleaning €397,01/time
 After the exhibition day, stands 501 m²-

PLANTS AND FLOWERS

With Ambius professionals, you can design an exhibition stand where your customers feel great. Plants and flowers create a pleasant environment for doing business and establishing contacts.

Renting indoor plants is both cost-effective and easy – we bring and collect the plants as agreed and ensure that they are in perfect condition during the entire event. If you need other decorative elements, such as cut flowers, we are only too pleased to help you. Other products also available. For more information, please call **+358 207 893 204** or e-mail viherkasvivuokraus@ambius.com.



701
Benjamin tree
150 cm €27



702
Benjamin tree
180 cm €35



705
Dragon tree
180 cm €35



710
Snake plant
80 cm €29



712
Three snake plants
in a pot €59

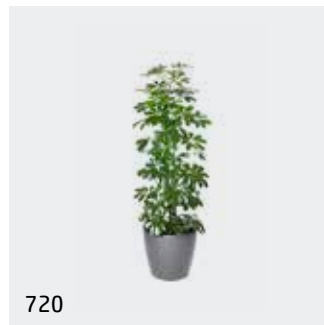

720
Umbrella plant
100 cm €27

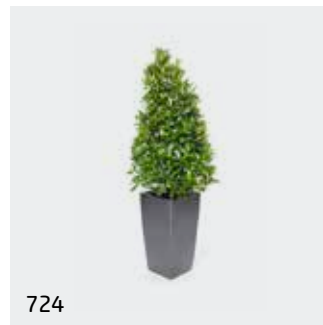

724
Sweet bag
120 cm €35

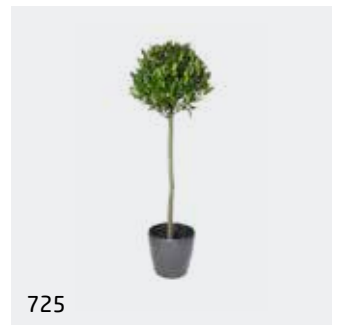

725
Sweet bag
160 cm €37



731
Kentia palm
150 cm €35



732
Kentia palm
200 cm €49



742
Zu Zu plant
80 cm €29



751
Ivy
80 cm €15

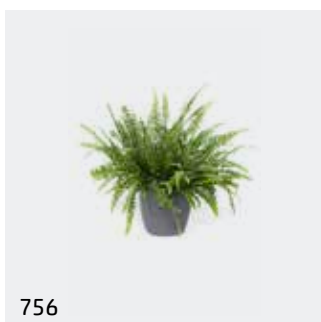

756
Sword fern
ø 40 cm €15

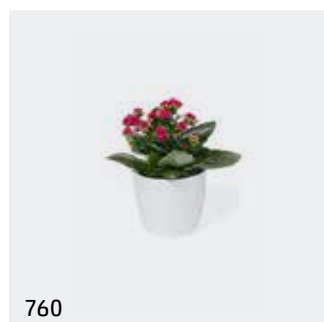

760
Seasonal flowers €6

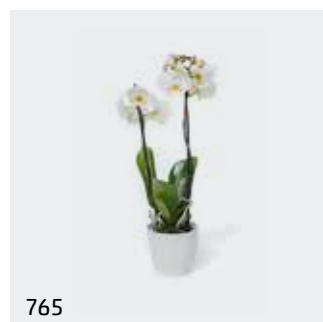

765
Orchid
40 cm €15



768
Mosswall
50x50 cm €59



772

Pot, white

€5



773

Pot, black

€5



774

Pot, red

€5



775

Black tall pot

€12



776

White tall pot

€12



777

Grey tall pot

€12



780

Plant and flower package

€80



781

Green interior decoration package

€180

HPAC SERVICES

The fixture rent includes max. 3 m installation materials at the stand. Other materials and parts used for installations and connections will be charged separately. Work will be charged according to actual hours worked. Water, drainage and pressured air installations requires an underfloor pit on the stand or in technical area.

Request for special offers such as pool fillings, special commodes, special faucets and information about order content:

Are Oy, Joonas Aho, [+358 403 006 351](tel:+358403006351), joonas.aho@are.fi



800

Compact kitchen unit, installed
(Cooking plate, sink with a tap and refrigerator) 100 x 60 x h 90 cm

€630



805

Design sink, installed
100 x 60 x h 93/95 cm

€672



816

Sink with a tap and electric water heater, installed
51 x 60 x h 90 cm (10 l)

€447



820

Sink with a tap and an electric water heater, installed
100 x 60 x h 90 cm (10 l)

€510

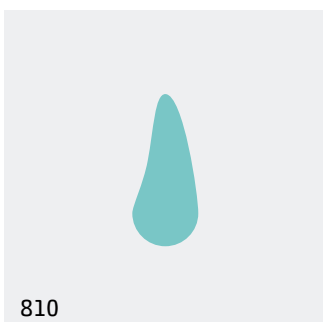

810

Warm water connection
To exhibitor's own equipment,
incl. 15 l boiler

€284

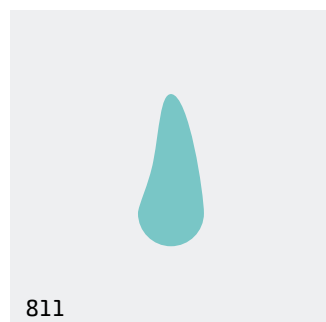

811

Warm water connection
To exhibitor's own equipment,
incl. 300 l boiler

€394



821

Table top dishwasher
Installed

€384



825

Cold water connection
To exhibitor's own equipment,
incl. one connection

€168

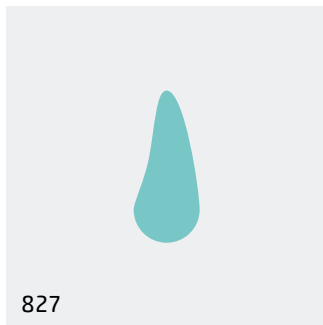

827

Drain connection €174
To exhibitor's own equipment, incl. one connection

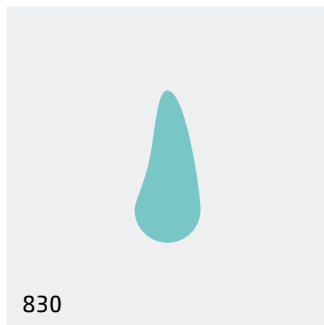

830

Filling and draining of water tank €132
0-500 l

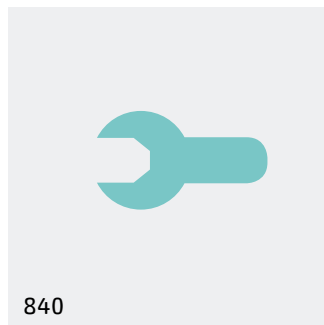

840

Compressed air connection €326
To the main pipe in the hall, incl. one connection to exhibitor's equipment

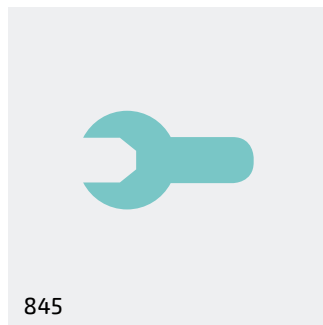

845

Additional compressed air connections €111
to the same stand

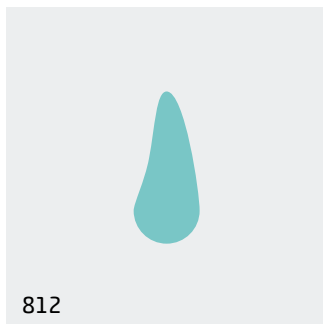

812

Cold water, warm water 15 l and drain connection €625



813

Cold water, warm water 300 l and drain connection €735

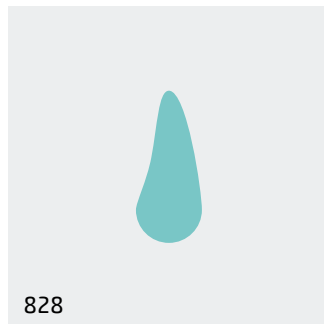

828

Cold water and drain connection €342

LOGISTICS SERVICES AND STORAGE

Niemi® Moving It All - Niemi® Events

Niemi is a specialist in event services. We provide organizers and exhibitors with all event exhibition-related logistics services. We offer everything from transportation and storage solutions to staffing and lifting services.

Contact: expo@niemi.fi

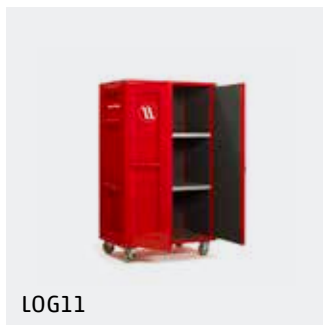

LOG11

Lockable moving cabinet €55
180 x 110 x 71 cm

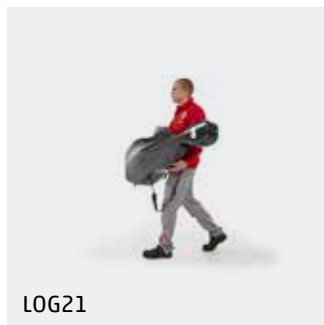

LOG21

Stand Assistant €440/day
Max. 12 hours



LOG31

Unloading or loading €550
Max. 13,6 load metres



LOG41

Small-scale deliveries €175/direction
To/from an event. Max. 3 pallets within Helsinki, Espoo, Vantaa and Kauniainen

SECURITY SERVICES

Securitas is the official security partner of Messukeskus. In addition to, the next security-/safety packages tailored for your stand, we can also provide you with all the specialized security-/safety services you might need. Such services might include for example, the protection of you key personnel and all the security planning/services, needed based on the up-to-date risk assessment.

We are at your disposal, please contact us by email: messukeskus@securitas.fi / or by phone; Tommi Sihvonen, **+358 40 196 2711** & Matti Malkamäki, **+358 707 5397**



SEC11

Manned security service €480/day
For your stand during the exhibition



SEC15

Manned security service €540/night
For your stand when the exhibition is closed to public



SEC21

Burglar alarm system €480
For your stand



SEC25

Fire alarm system €480
For your stand

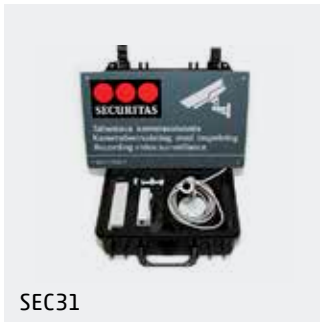

SEC31

Recording CCTV-system €480
For your stand



SEC41

A complete technical solution €790
To secure your stand: Burglar alarm, Recording CCTV

CONFERENCE SERVICES

Messukeskus Helsinki has 40 different-sized conference facilities for meetings, seminars and galas. Our experience of thousands of events, our versatile premises for 6–1 100 guests and high-class conference services enable successful encounters. We are happy to help you with all the event services weather you need to find a suitable meeting room, latest technology or catering. We take care that the room is ready when your clients arrive. Let's organize a memorable event together!

Take a virtual tour: messukeskus.com/facilities

Request an offer: messukeskus.com/offer

Book a meeting room for 2–16 people: messukeskus.com/smallmeeting

Conference sales: +358 40 450 3251, sales@messukeskus.com

EXHIBITION CATERING SERVICES

Fazer has been responsible for the versatile and high-quality restaurant services at Messukeskus since 1997. At the Helsinki Expo and Convention Centre, the focus of operations is, in accordance with the centre's name, on exhibitions and fairs. Catering services can be ordered in advance through the link to the Lytyi-booking system:

www.fazer.fi/kahvilat-ja-leipomot/messukeskus/messukeskus-expo-and-convention-centre-helsinki/

The service order has to be made 3 week days before the fair. Preordered products will be delivered to your booth daily before opening of the fair or the time the customer has requested.

Fazer Food Services is in charge of serving alcoholic beverages at the premises in Messukeskus. It is not allowed to bring any alcoholic beverages of your own to the restaurant premises (Finnish alcohol law). Alcoholic beverages can be ordered from Fazer sales office:

fazer.sales@messukeskus.com or call +358 404 503 252

Ask a catering offer and our sales office will take notice your needs to your booth:

fazer.sales@messukeskus.com or call +358 404 503 252.

Additional catering services during the fair call +358 504 659 216.



HOTEL SERVICES

At a fair if anywhere, even a few minutes can be precious. Not to mention waking up peacefully in a comfortable bed, enjoying a hearty breakfast in the hotel breakfast room and then dashing off to work under the same roof. When you stay at the Holiday Inn Helsinki - Messukeskus, your neighbour is the Helsinki Exhibition and Convention Centre and the trip to work is a breeze; no waiting for a taxi or circling to find a parking space. It's that easy when you're our guest and stay next door to the Helsinki Exhibition and Convention Centre!

The Holiday Inn Helsinki - Messukeskus hotel is located just a few minutes from the Helsinki city centre; a few minutes by taxi, tram or train and Helsinki Airport is also easy to reach; 15 minutes by taxi.

With this perfect location for business and leisure travel, this high-standard hotel offers 244 spacious rooms. All our rooms come with complimentary Wi-Fi, air-conditioning, hospitality tray with coffee and tea facilities, ironing equipment and our famous Pillow Menu. The Executive Rooms on the 9th floor and our Suites cater for the discerned business traveler and offer adjustable air-conditioning, in-room safe, bathrobe and slippers. The hotel offers free access to Minigym and Finnish Sauna. There is also a garage with 60 places.

More information and bookings: Holiday Inn Helsinki - Messukeskus, tel. +358 200 481 02 (0,17 €/puh + 0,75 €/min), helsinki.holidayinn@restel.fi, www.holidayinn.com/hihelsinki

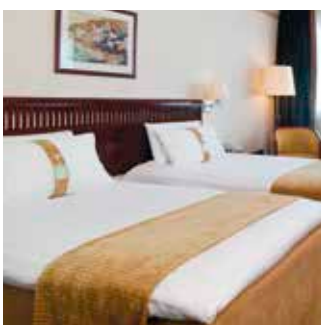

RENTAL TERMS

The prices for structures and furnishing cover the rental, installation and dismantling costs for the whole exhibition. In the event that an ordered product delivered to the stand is cancelled, Messukeskus reserves the right to charge the full price.

The rented structures and furnishing are intended for interior use only. Profile and standard structures are separate structures which cannot be combined. In the interests of safety, Messukeskus may increase the number of supporting structures at the exhibitor's expense. Objects may only be affixed to profile structures using light adhesive tape or decoration hooks. With standard structures, you can use adhesive tape or small screws. The adhesives, screws and nails must be removed by the exhibitor. If they are not removed, Messukeskus reserves the right to charge the costs of their removal from the exhibitor.

The charges for electricity include the rental for fixtures, cables and other installation materials as well as the installation and dismantling work. If additional support channels, cable wires or other materials are needed for installing light fittings, busbars or for other special work, a separate charge shall be applied for the materials and installation. Electrical installations at Messukeskus are carried out by PKS-Talotekniikka Oy, a subcontractor to Messukeskus. Exhibitors' electrical equipment must fulfil the requirements of the SFS 6000-7-711 standard. Socket groups below 20 A must be furnished with 30 mA faulty-current circuit breakers.

The prices for AV equipment include the rental and the cost of installation and dismantling unless otherwise stated.

Exhibitors are expected to compensate in full for any damaged or lost structures, furnishing, AV equipment and electrical fittings and supplies.

All rights reserved. Any complaints shall be issued during the exhibition to the Exhibition Office.

PAYMENT TERMS

Applicable VAT will be added to the prices. The payment terms is 14 days net unless otherwise indicated. The penalty interest is 16%.

Orders received no later than 30 days before the exhibition will be charged according to the price list. In some of the products and services there is a rush fee of 20% if the order is made 29-8 days before the event and 50% if the order is made 7 days before the event. Please check the current price at www.emessukeskus.com.

An invoicing fee (€20/invoice) will be charged for a new invoice due to changes in company contact information or, in the case of a joint stand, if a rental or technical service invoice is divided between several companies.